



The  
Fountainhead  
Group, Inc.



**DBL500**

# Indian Chief Fire Pump

*Use and Care Manual*



## **⚠ CAUTION: Read and follow all instructions**

Do Not Return This Indian Chief Fire Pump To The Store  
For Help, Information or Parts, Call : 1-800-311-9903

**The Fountainhead Group, Inc.**

23 Garden St., New York Mills, NY 13417

1-800-311-9903

[www.TheFountainheadGroup.com](http://www.TheFountainheadGroup.com)

Manual No. 181797  
Rev G. 02/27/19  
ECN19-015

5 1/2" x 8 1/2" Booklet

## Congratulations on purchasing our DBL500 Indian Chief Fire Pump!

- Pump is rust proof and provides a positive shutoff at any position with no drip off or waste of water.
- Combination nozzle allows for operator to change from a straight stream to a cone spray quickly and easily without any special tools.
- Pump is unaffected by non-use or long periods of storage.
- Shoulder strap is equipped with clip to hold pump, freeing up hands.
- Approved by US Forestry Service.

## SAFETY PRECAUTIONS

- Read owner's manual completely before operating this Indian Chief Fire Pump.
- Read and follow all instructions and cautions on label of products used in this Indian Chief Fire Pump.
- Never use flammable liquids, caustics, acids, or hot water in this bag.
- Do not leave Indian Chief Fire Pump in the sun when not in use.
- Always inspect hose and all hose connections before each use.
- Do not lift or carry Indian Chief Fire Pump by the hose or pump. Carry by the handle only.
- Do not store or use chemicals in this bag.
- Clean and rinse Indian Chief Fire Pump thoroughly after each use.
- Never attempt to alter Indian Chief Fire Pump from original condition.
- Keep the Indian Chief Fire Pump out of the reach of children.

## Operating Instructions

### Filling

1. Disconnect hose from bag by pushing down on the quick disconnect fitting sleeve and removing hose connector. ( See Figure 3. )
2. Remove the cap from the bag by turning it counterclockwise.
3. Fill the bag with water to the desired level.
4. Reinstall the cap. Turn the cap clockwise, tighten down securely.
5. Connect hose to bag quick disconnect fitting. ( See Figures 3.-5. )

### Spraying

1. Determine which spray pattern is desired. The nozzle has a single-hole option for a stream pattern or a two-hole option for a fan pattern.  
( See Figure 1. )

**NOTE: A foaming nozzle is available as an accessory. The foaming nozzle should be used if a fire fighting (foam) additive is used in the bag.**

2. Screw the appropriate nozzle option onto the end of the pump and hand tighten.
3. Operate the pump by sliding the handle in and out of the pump body. The pump will fill the cylinder with water on the "out" stroke and discharge the water on the "in" stroke.

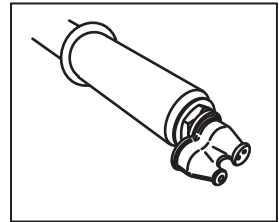

Figure 1. Pump Nozzle Installation

### Pump Maintenance

1. After each use or before storage, pump clean water through the pump to remove any dirt or debris.
2. Apply a few drops of light oil or grease at the gland nut to ease the pump operation. (See Figure 2. )
3. Regularly check the nozzle for dirt or debris that may affect the spray pattern.
4. Regularly check the hose for cracks. Replace the hose if any cracks are found.

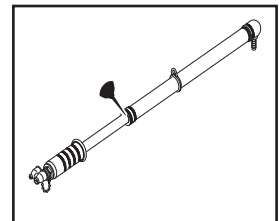

Figure 2. Pump Lubrication

### Connecting / Disconnecting hose to bag.

When connecting or disconnecting hose assembly to bag push down on bag quick disconnect fitting sleeve on outside. This opens the connector up so the hose connector will fit in. (See Figure 3.)



Figure 3.

Push hose connector into the quick disconnect fitting. (See Figure 4.)

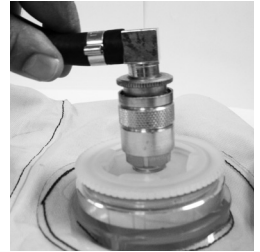

Figure 4.

Hose connector is connected correctly when outside sleeve on the quick disconnect fitting is up as shown. (See Figure 5.)



Figure 5.

### Extra Liner

Extra liner is stored in the front pouch of the bag. (See Figure 6.)



Figure 6.

### Replacing Liner

(Will need a 7/8" open end or adjustable wrench.)



NOTE:

- 1.) REMOVE CAP FROM OLD LINER. USE WRENCH TO REMOVE QUICK DISCONNECT FITTING FROM OLD CAP.
- 2.) REMOVE CAP FOR NEW LINER. **IMPORTANT: DO NOT INSTALL QUICK DISCONNECT FITTING INTO CAP WHILE CAP IS INSTALLED IN LINER.**
- 3.) APPLY 2 WRAPS OF TEFLON TAPE TO THREAD ON QUICK DISCONNECT FITTING (#176050).
- 4.) INSTALL QUICK DISCONNECT FITTING INTO NEW CAP USING WRENCH, TIGHTEN SECURELY.
- 5.) REINSTALL CAP INTO NEW LINER, TIGHTEN SECURELY BY HAND.
- 6.) INSTALL NEW LINER INTO CANVAS BAG.

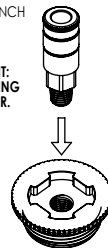

\*WRAP TEFLON TAPE AROUND THREAD IN CLOCKWISE FASHION.

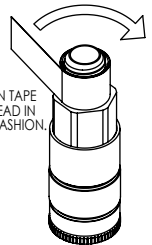

**PARTS & ACCESSORIES**

PART#	DESCRIPTION
175753	Hose Only (Sold by the foot)
175752	Hose Assembly, 4'
180481	Foaming Nozzle
175854	Twin Nozzle W/Chain And Ring
176009	Hose Clamp *
175764	Slide Pump Complete W/Twin Nozzle
175785	Cap Nut
175786	Felt Wiping Ring
182177	Sleeve

PART#	DESCRIPTION
175863	Outside Cylinder Assembly
180328	Foot Valve Assembly
175875	Hose Connector
181790	Bag Assembly DBL500
181791	Shoulder Harness DBL500
181798	Liner with Cap
176050	Quick Disconnect Fitting

\* Worm Gear Hose Clamp (Screw On) Used To Replace Original Crimp On Clamp

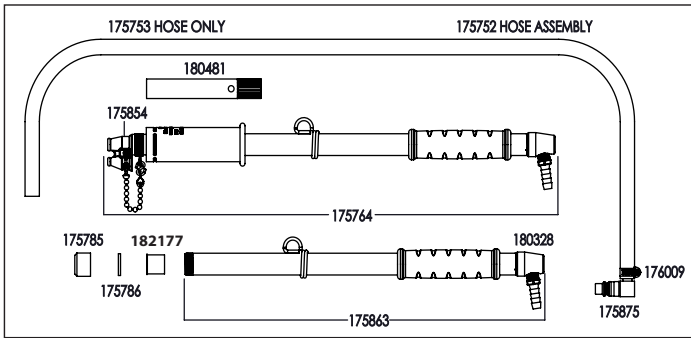

181790

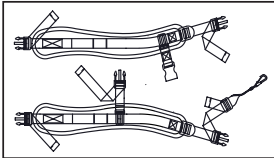

181791



181798

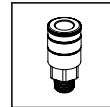

176050

**1-Year Limited Warranty**

We warrant that each product sold by us will be free from defects in material and workmanship for a period of one year from the date of shipment by us. We make no other express warranties, and all implied warranties, including fitness and merchantability, are limited to one year from the date of shipment by us. Within the warranty period, we will repair or replace any part found to be defective upon our examination but will not pay shipping cost or other expenses. To obtain warranty service, contact us at: Customer Service, 23 Garden Street, New York Mills, New York 13417, or call prepaid, Area Code (800) 311-9903 or (315) 736-0037. Merchandise may not be returned without prior permission and must be returned to us prepaid. This warranty service is an exclusive remedy and we are not responsible for any consequential or incidental damages or injury to person(s) or property. This warranty shall not apply to any product which has been subject to misuse, negligence or accident, or been damaged in shipment, or misapplied, or which has been modified or repaired by unauthorized persons. This warranty only applies to products owned by persons purchasing directly from us or from our approved distributors and merchandisers. The right is reserved to incorporate subsequent design or parts changes after publication and without reissue of descriptive literature or catalogs. NOTE: Limitations on duration of implied warranty and/or consequential damages might not apply to you if your state does not permit them. This warranty gives you specific legal rights in addition to rights you may have under state law.

**PARTS & ACCESSORIES ARE AVAILABLE BY CONTACTING**

The Fountainhead Group, Inc. - Customer Service Center

Monday - Friday 8 A.M. - 5 P.M., EST

Toll Free: 1-800-311-9903 or e-mail: [Info@TheFGI.com](mailto:Info@TheFGI.com)

or

Access online at: [www.TheFountainheadGroup.com](http://www.TheFountainheadGroup.com)