



The  
Fountainhead  
Group, Inc.

# Backpack Sprayer

*Use and Care Manual*



**⚠ CAUTION: Read and follow all instructions**

Do Not Return This Backpack To The Store  
For Help, Information or Parts, Call : 1-800-311-9903

**The Fountainhead Group, Inc.**  
23 Garden St., New York Mills, NY 13417

1-800-311-9903

[www.TheFountainheadGroup.com](http://www.TheFountainheadGroup.com)



## **⚠ SAFETY PRECAUTIONS**

- Read owner's manual completely before operating this sprayer.
- Always use goggles, gloves, and protective clothing when using sprayer.
- Read and follow all instructions and cautions on label of products used in this sprayer.
- Never use flammable liquids, caustics, acids, or hot water in this tank.
- Do not leave sprayer in the sun when not in use.
- Spray when air is calm to prevent drift of chemicals.
- Do not use sprayer near open flame or anything that could cause ignition of the spray.
- Always inspect hose and all hose connections before each use. A damaged hose, or loose hose connection can result in unintended exposure to the pressurized chemical, resulting in serious injury or property damage.
- Do not lift or carry sprayer by the hose, shut-off valve, or wand extension. Carry by the handle only.
- Do not pressurize with any mechanical device such as an air compressor, since this can create a dangerous pressure level and bursting of parts resulting in serious injury. Only use original pump.
- Do not store chemicals in this tank.
- Always release pressure when sprayer is not in use and before performing any maintenance.
- **Clean and rinse sprayer thoroughly after each use.**
- Never attempt to alter sprayer from original condition.
- Always use replacement parts from original manufacturer.
- Keep the sprayer and all chemicals out of the reach of children.

## **⚠ WARNING**

**ALWAYS CLEAN THE SPRAYER AND SHUT-OFF THOROUGHLY AFTER EACH USE OR WHEN CHANGING APPLICATIONS AS DESCRIBED IN THE *CLEANING* SECTION. FAILURE TO COMPLETELY CLEAN MAY CAUSE CROSS-CONTAMINATION.**

## **⚠ CAUTION**

Always empty, clean and dry tank, pump system, shut-off, hose, and extension after each use. FAILURE TO DO SO MAY WEAKEN SPRAYER COMPONENTS, CAUSING COMPONENTS TO RUPTURE WHEN PRESSURIZED. Additionally, FAILURE TO CLEAN AND PROPERLY MAINTAIN YOUR SPRAYER WILL VOID MANUFACTURER'S WARRANTY.

## **⚠ WARNING**

The sprayer is operated with liquid under pressure. Failure to observe caution and to follow instructions for operating and cleaning can cause tank, hose and other parts to be weakened and rupture under pressure. This can result in serious injury from high pressure discharge of liquids or forcible ejection of parts. Do not use flammable materials in this sprayer. Material could ignite or explode, causing serious injury and/or possible death. For safe use of this product, you must read and follow all instructions before use.

**TEST SPRAYER WITH WATER BEFORE USING ANY CHEMICALS.**

**Do not return sprayer to store, if you experience problems or have questions contact our toll free Customer Service Center, M-F 8AM - 5PM, EST, at 1-800-311-9903, or e-mail: [Info@TheFGI.com](mailto:Info@TheFGI.com), or access online at: [www.TheFountainheadGroup.com](http://www.TheFountainheadGroup.com).**

# ASSEMBLY INSTRUCTIONS

## Assemble Extension, Shut-Off, Nozzle and Spray Optimizer



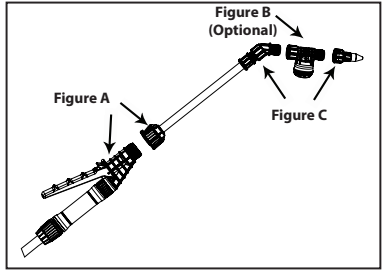

1. Install the extension "wand" onto the shut-off assembly and tighten the nut securely. (See Figure A)
2. (Optional) Install Spray Optimizer for low pressure (low drift) applications. This will help prevent weed killer formulas from drifting into undesired areas. (**Do not over tighten, actual position will vary. See Figure B**)
3. Install selected nozzle onto the end of the extension or optimizer (if installed) and tighten securely. (See Figure C)

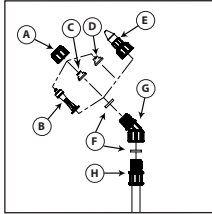

SELECT USING NOZZLE CHART BELOW  
(Nozzle selections vary by model)



- A. Cap Nut
- B. Foaming Nozzle
- C. Red High-Volume Fan Nozzle
- D. Yellow Low-Volume Fan Nozzle
- E. Adjustable Cone Nozzle
- F. Flat Seal
- G. Adapter
- H. Extension

ADJUSTABLE CONE USES:	FOAMING NOZZLE USES:
 <ul style="list-style-type: none"> <li>• Spot spraying in or around flower beds, trees, and shrubs.</li> <li>• Edging along fences, driveways, and walkways.</li> <li>• Killing brush such as poison ivy, poison oak, kudzu and wild blackberry.</li> <li>• Preparing garden beds for planting of ornamentals and vegetables.</li> </ul>	 <ul style="list-style-type: none"> <li>• Spot spraying in flower beds, walkways, driveways, and patios, around trees and shrubs.</li> <li>• Edging along fences, driveways and walkways.</li> <li>• Killing brush such as poison ivy, poison oak, kudzu and wild blackberry.</li> </ul>
RED HIGH VOLUME FAN NOZZLE USES:	YELLOW LOW VOLUME FAN NOZZLE USES:
 <ul style="list-style-type: none"> <li>• Lawn replacement. Kill lawn and weeds before planting a new lawn.</li> <li>• Preparing large areas for planting of ornamental and vegetable gardens.</li> </ul>	 <ul style="list-style-type: none"> <li>• For precision spraying in confined areas such as gardens and flower beds.</li> </ul>

## Assemble Pump Handle

Slide handle onto shaft and line up holes. Thread bolt through handle and shaft and securely tighten. Thread on lock nut and tighten using a 13mm (or adjustable) wrench. Handle can be mounted on left or right depending on user preference. (See Figure D)

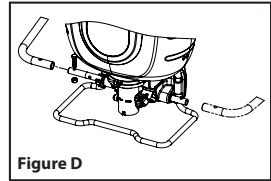

# OPERATING INSTRUCTIONS

**Always conduct a test using cool, clean water before mixing chemicals.**

## Filling

**Always refer to chemical manufacturer for proper mixture.**

1. Remove the cap from the tank.
2. Make sure the filter basket is in place in the neck of the tank. The filter basket includes the seal and must be in place to prevent leaks.
3. Fill the tank with cool water and chemical to the desired level.
4. Reinstall the cap.

## Pressurizing and Spraying

1. To begin pressurizing, be sure shut-off lever is not depressed. Pump handle up and down in a smooth motion (See Figure E). Operating pressure is reached when pumping becomes difficult, which is no more than 4-6 full pumps. (**Do not over-pressurize**)
2. Direct nozzle away from you and squeeze shut-off lever to begin spraying.

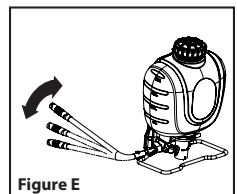

- To maintain pressure while spraying, operate pump handle every 8 sec. or as needed.
- For continuous spraying, squeeze lever and rotate lock. (See **Figure F**)
- Unlock if needed and release shut-off lever to stop spraying.

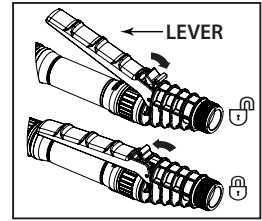

**Figure F**

### **Cleaning**

- Fill the tank with cool, clean tap water. Replace the cap and tighten securely. (**Note: Never use hot water for cleaning.**)
- Agitate the tank to rinse the chemical from the tank walls.
- Remove the cap and empty the contents into gravel or bare soil.
- Refill the tank with clean tap water. Replace the cap and tighten securely.
- Pressurize the tank as described in the *Pressurizing and Spraying* section.
- Direct the nozzle away from you and activate the shut-off for at least 30 seconds to clean the pressure cylinder, hose and shut-off.
- Remove the cap and empty the contents into gravel or bare soil.
- Repeat steps 4 - 7 until thoroughly cleaned. Remove nozzle when flushing pump system. Clean nozzle before replacing.

### **Sprayer Storage**

- Never store sprayer with pressure in reservoir or liquid in any part of sprayer.
- Sprayer tank should be hung upside down, with the cap removed, to dry completely.
- Do not store or leave any solution in the tank after use.
- Store in a warm, dry location out of direct sunlight.
- Keep the sprayer and all chemicals out of the reach of children.**

## MAINTENANCE

### **Tank Maintenance**

- After each use, rinse the tank with cool, clean water.
- Check the check valve (See **Figure G**) and filter basket gasket (See **Figure H**). Make sure they do not show signs of wear and are operating properly. Replace them as required.
- Clean any dirt or debris from the filter basket.
- Periodically check the straps for fraying. Replace them as required.

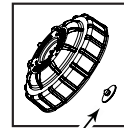

**Figure G**

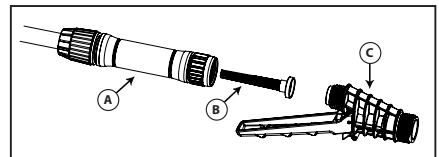

**Figure H**

### **Shut-off Maintenance (Smith Pro II)**

**Always depressurize sprayer before maintenance by activating shut-off and spraying contents out.**

- Unscrew the handle from the shut-off assembly.
- Remove the filter from the shut-off assembly.
- Clean any debris from inside the handle, shut-off assembly, or the filter by rinsing with cool, clean water.
- Reassemble the components as shown and tighten all connections securely.



**A. Handle**  
**B. Filter**  
**C. Shut-off Assembly**

### **Nozzle Maintenance**

- If nozzle clogs, remove and disassemble the nozzle assembly.
- Clean the openings of any obstructions and reassemble.

# SERVICING INSTRUCTIONS

## Disassemble and Repair

Prior to performing any maintenance or repairs empty contents of tank. Pump any remaining fluid out of the pump. Lock trigger and spray all fluid out of shut-off until all fluid and air pressure has been expelled.

## Servicing Steps

1. Position pump handle all the way up, placing the piston in the down stroke to allow access to the screws retaining the crank arms. Remove the pump handle. **(See Figure 1)**
2. Remove the four screws securing the crank arm to the drive shaft using a 6mm Allen Wrench. **(See Figure 2)**
3. Next remove the screw that secures the crank arms to the drive links using a 5mm Allen Wrench. **(See Figure 3)**

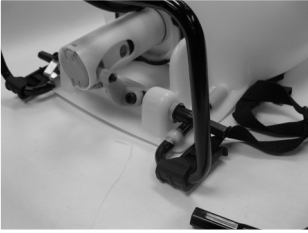

Figure 1



Figure 2



Figure 3

4. Remove the pump cover by inserting a flat head screwdriver into the lower snap windows of the pump cylinder. **(See Figure 4)**
5. Withdraw the crank arms from the drive link through the side of the pump cylinder. **(See Figure 5)**
6. Now the drive link and piston assembly can be removed straight down through the bottom of the pump cylinder. **(See Figure 6)**



Figure 4

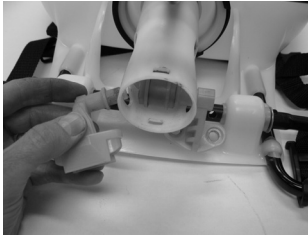

Figure 5



Figure 6

7. The piston cup and cylinder walls should be periodically cleaned and recoated with fresh petroleum jelly. Take note of any tears or scratches and replace as needed. Take care to guide the piston cup past the side openings in the pump cylinder when reinstalling. **(See Figure 7)**
8. You will need the piston seal kit to rebuild the pump cylinder assembly. First remove the pump cylinder by unscrewing it counterclockwise. **(See Figure 8)**
9. Use a Phillips head screwdriver to remove and discard the pump cylinder washers, saving the screw and stainless steel washers. Replace with new. Do not grease pump cylinder washers. Inspect o-rings for wear and replace with new and/or lubricate with petroleum jelly. **(See Figure 9)**

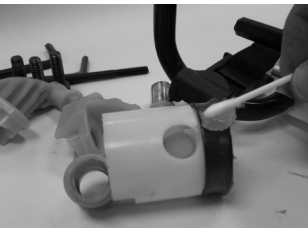

Figure 7



Figure 8

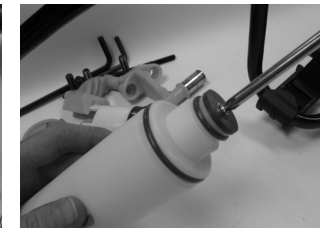

Figure 9

## SERVICING INSTRUCTIONS CONTINUED

10. To reinstall the pump cylinder, rethread into the pressure cylinder until the large o-ring is not visible then continue turning until the tab and notch align. **(See Figure 10)**
11. To replace the pressure cylinder o-ring, remove the pressure cylinder by loosening and removing the clamp ring that retains the pressure cylinder. Use a block of wood for a punch to drive the pressure cylinder out of the bottom tank opening. Withdraw the pressure cylinder and remove the old o-ring. Clean the seal groove and mating tank surface with a soft cloth. Replace the o-ring and coat with petroleum jelly. **(See Figure 11)**
12. To reinstall pressure cylinder first warm the bottom tank opening by running it under hot tap water. This will ensure that the pressure cylinder seal is seated properly. Take care not to roll the o-ring seal out of the groove as you reinsert the pressure cylinder. Realign the tab on the tank with the notch on the pressure cylinder and make sure the flange on the pressure cylinder is flush with the flange on the tank. Reassemble the clamp ring and tighten. **(See Figure 12)**



Figure 10



Figure 11

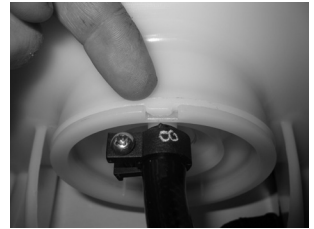

Figure 12

### **Harness Installation**

1. For each side, remove the small plastic clips from the two shoulder strap loops and thread each loop through the slots at the top of the carry handle. **(See Figure 13)**
2. Replace the clips through the loops clamping the two shoulder straps securely. **(See Figure 14)**
3. To install lower portion of the straps, remove strap from top portion of buckles and place around the foot stand, starting from underneath. **(See Figure 15)**
4. Loop strap through the first section of the buckle. **(See Figure 16)**
5. Next loop strap through other section of buckle and tighten **(See Figure 17)**. Adjust the shoulder pads and strap length for a comfortable fit.

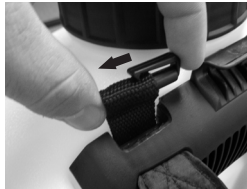

Figure 13



Figure 14



Figure 15

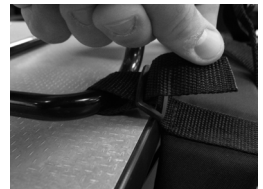

Figure 16



Figure 17





## TROUBLESHOOTING

<b>TROUBLE</b>	<b>LOOK FOR</b>	<b>REMEDY</b>
Sprayer will not build pressure.	<ol style="list-style-type: none"> <li>1. Piston Seal (#34E) on pump piston is worn or damaged.</li> <li>2. Pump Cylinder Washer (#34B) may be dirty or damaged.</li> </ol>	<ol style="list-style-type: none"> <li>1. Replace Piston Seal (#34E).</li> <li>2. Flush pump with clean water to remove any debris from the Pump Cylinder Washer (#34B) or replace.</li> </ol>
Sprayer leaks from the bottom of tank.	<ol style="list-style-type: none"> <li>1. Piston Seal (#34E) may be worn or damaged.</li> <li>2. Damaged or worn o-ring(s).</li> </ol>	<ol style="list-style-type: none"> <li>1. Inspect and lubricate Piston Seal (#34E). If damaged, replace.</li> <li>2. Lubricate or replace o-ring(s).</li> </ol>
Sprayer will not spray.	Shut-Off Nozzle is clogged.	Clean Shut-Off or Nozzle as described in <i>Maintenance</i> Section.
Pump handle is difficult to operate.	<ol style="list-style-type: none"> <li>1. Swollen or damaged Piston Seal (#34E).</li> <li>2. Dirty Drive Shaft Bushing (#9).</li> </ol>	<ol style="list-style-type: none"> <li>1. Clean and lubricate Piston Seal (#34E) and Pump Cylinder (#6) with petroleum jelly or replace.</li> <li>2. Lubricate Bushing (#9) with petroleum jelly.</li> </ol>
Sprayer builds too much resistance after just a few pump strokes and only maintains pressure briefly.	Little to no air in the Pressure Cylinder (#5).	Holding shut-off below tank, drain Pressure Cylinder (#5) by activating lever on shut-off until all liquid is expelled.
Increased resistance when pulling pump handle up or handle moves down on its own.	<ol style="list-style-type: none"> <li>1. Pump Cylinder Washer (#34B) is sticking.</li> <li>2. Check Valve (#34F) hole is clogged.</li> <li>3. Filter in Pressure Cylinder (#5) is clogged.</li> </ol>	<ol style="list-style-type: none"> <li>1. Clean or replace Pump Cylinder Washer (#34B).</li> <li>2. Clean Check Valve (#34F)</li> <li>3. Clean permanent filter within Pressure Cylinder (#5).</li> </ol>

# KITS, PARTS & ACCESSORIES

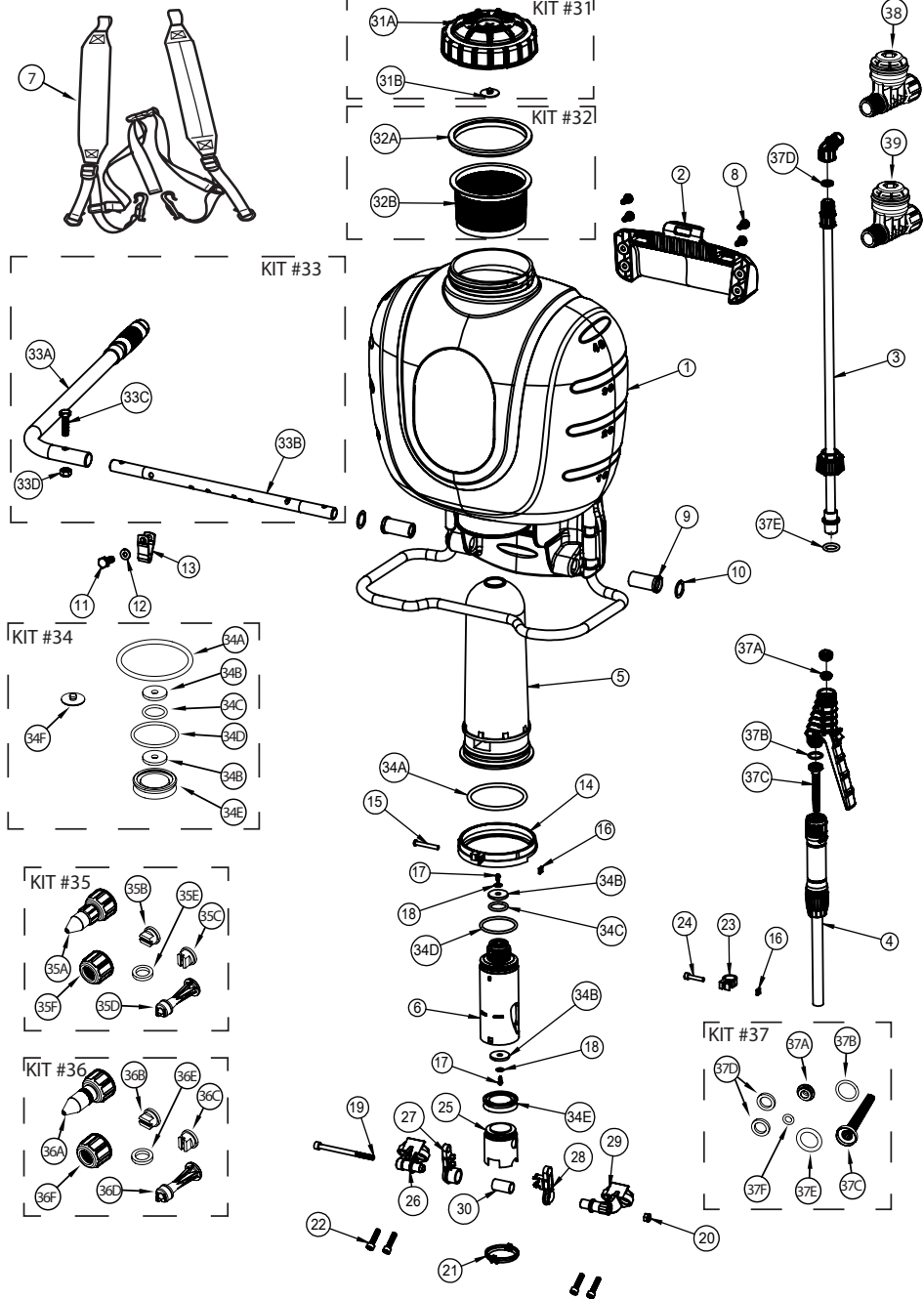

KEY#	PART#	DESCRIPTION
1	181521	TANK WITH FOOT STAND
2	181528	CARRY HANDLE
3	181824	21" WAND ASSEMBLY
4	181820	HOSE & SHUT-OFF, SMITH PRO II
5	181495	PRESSURE CYLINDER
6	181500	PUMP CYLINDER
7	181537	SHOULDER HARNESS
8	181529	SCREW, UPPER HANDLE (4)
9	181508	DRIVE SHAFT BUSHING (2)
10	181507	DRIVE SHAFT WASHER (2)
11	181525	STOP BRACKET BOLT
12	181524	STOP BRACKET WASHER
13	181523	STOP BRACKET
14	181509	CLAMP RING
15	181510	CLAMP SCREW
16	181511	CLAMP NUT (2)
17	181502	SELF TAPPING SCREW (2)
18	181501	STAINLESS STEEL WASHER (2)
19	181531	PISTON SCREW
20	181536	PISTON NUT
21	181514	PUMP COVER
22	181518	BELL CRANK SCREW (4)
23	181512	HOSE CLAMP
24	181513	HOSE CLAMP SCREW
25	181504	PUMP PISTON
26	181526	LEFT BELL CRANK
27	181506	FEMALE DRIVE LINK
28	181505	MALE DRIVE LINK
29	181527	RIGHT BELL CRANK
30	181522	SLEEVE

**KIT #31 181446 CAP ASSEMBLY KIT**

31A	181444	TANK CAP
31B	171015	CHECK VALVE

**KIT #32 181564 FILTER BASKET ASSEMBLY KIT**

32A	181445	FILTER BASKET GASKET
32B	181519	FILTER BASKET

**KIT #33 181787 BOLT-ON PUMP HANDLE KIT**

33A	181921	PUMP HANDLE ASSEMBLY (GRIP INCLUDED)
33B	181745	BOLT-ON DRIVE SHAFT
33C	181756	BOLT
33D	181757	LOCK NUT

**KIT #34 181567 PISTON SEAL KIT**

34A	181496	PRESSURE CYLINDER O-RING
34B	181497	PUMP CYLINDER WASHER (2)
34C	181498	SMALL PUMP CYLINDER O-RING
34D	181499	LARGE PUMP CYLINDER O-RING
34E	181503	PISTON SEAL
34F	171015	CHECK VALVE

**KIT #35 181869 POLY NOZZLE KIT**

35A	181822	POLY ADJUSTABLE NOZZLE
35B	180168	YELLOW FLAT FAN NOZZLE (LOW VOLUME)
35C	180097	RED FLAT FAN NOZZLE (HIGH VOLUME)
35D	180266	FOAMING NOZZLE
35E	181812	FLAT NOZZLE SEAL
35F	181804	NOZZLE CAP NUT

**KIT #36 181870 BRASS NOZZLE KIT**

36A	181823	BRASS ADJUSTABLE NOZZLE
36B	180168	YELLOW FLAT FAN NOZZLE (LOW VOLUME)
36C	180097	RED FLAT FAN NOZZLE (HIGH VOLUME)
36D	180266	FOAMING NOZZLE
36E	181812	FLAT NOZZLE SEAL
36F	181804	NOZZLE CAP NUT

**KIT #37 181910 SMITH PRO II SHUT-OFF SERVICE KIT**

37A	181840	POPPET SEAL
37B	181493	VALVE BODY O-RING
37C	181468	FILTER
37D	181812	FLAT NOZZLE SEAL (2)
37E	181810	WAND O-RING
37F	181805	ADJUSTABLE NOZZLE O-RING

**KIT #38 181826 25 PSI PRESSURE REGULATOR KIT**

17	181826	25 PSI PRESSURE REGULATOR ASSEMBLY
----	--------	------------------------------------

**KIT #39 181825 14 PSI PRESSURE REGULATOR KIT**

39	181825	14 PSI PRESSURE REGULATOR ASSEMBLY
----	--------	------------------------------------

**SERVICE KITS, PARTS & ACCESSORIES ARE AVAILABLE BY CONTACTING**

The Fountainhead Group, Inc. - Customer Service Center

Monday - Friday 8 A.M. - 5 P.M., EST

Toll Free: 1-800-311-9903

or

e-mail: [Info@TheFGI.com](mailto:Info@TheFGI.com)

or

Access online at: [www.TheFountainheadGroup.com](http://www.TheFountainheadGroup.com)